



# TACTIC DYNAMIC

---

## TRAFFIC INFORMATION SYSTEM



FEND OFF 45°



IN APP CONTROL

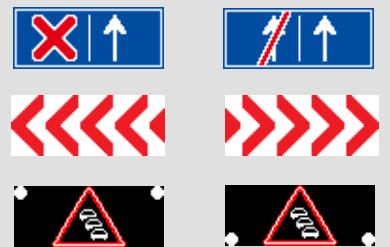

UNLIMITED VISUALIZATION

TTI PARTNERS BV

Dijkgraaf 14  
NL-6921RL Duiven, Nederland

Zijlweg 14  
NL-5145 NR Waalwijk, Nederland

CONTACT

T: +31 (0)88 010 81 88

E: [sales@ttipartners.com](mailto:sales@ttipartners.com)

W: [ttipartners.com](http://ttipartners.com)

# TACTIC DYNAMIC

## PRODUCT INFORMATION



“ A MOBILE TRAFFIC INFORMATION SYSTEM THAT EXISTS OF AN INFORMATION DISPLAY WITH INTEGRATED OPTICAL SIGNALLING. THE SOLUTION FOR SAFER ROADS. ”

### LED-DISPLAY

- Rotatable up to 45° to the left or right for Fend-Off position
- Full Color LED-Display L3/C2/B6/R3



### FRAME

- Dynamic Route Information Panel with 360° amber optical signalling
- Low product weight of 75 KG within permissible roofload of car manufacturers
- Corrosion resistant framework made of stainless steel and aluminium
- Driveable up to 130 km/h with an open and operational TACTIC
- Low total cost of ownership due to high quality parts
- Cover ABS RAL9016
- Vehicle independent



### CONTROL UNIT

- Operated by a mounted touchscreen in the cabin or tablet (Wi-Fi connection)
- Preinstalled images and texts



### OPTIONS

- Optical signalling used by hard buttons in cabin
- Integration of other communication resources possible
- Unlimited personalised texts, images and scenarios available
- Cover in any (RAL) color possible, including logo



A PRODUCT ACCORDING TO THE LAST TECHNICAL DEVELOPMENTS  
AN INNOVATIVE, EFFECTIVE AND SOLVING PRODUCT

# TACTIC DYNAMIC

## TECHNICAL INFORMATION

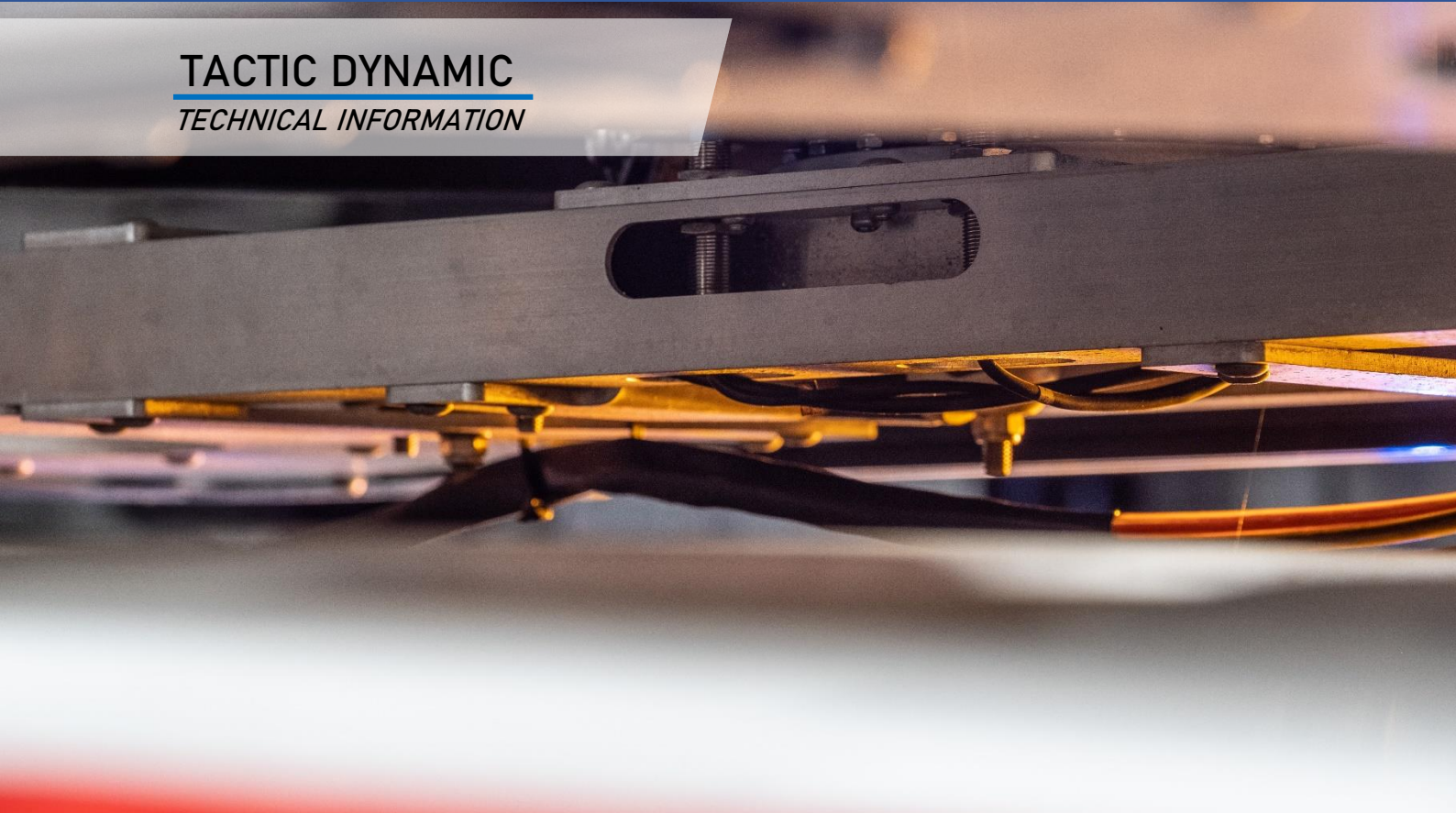

“ WORKING SAFE ON THE ROAD DUE TO TECHNICAL INNOVATION. THATS WHAT TTI PARTNERS BV STANDS FOR. ”

### DISPLAY DETAILS

- Resolution: 80 x 32 pixels (Ø 12 mm) 2560 pixels 3<sup>th</sup> generation Surface Mount Technologies LEDs
- Fend-Off position in 5 seconds (45° left and right)
- Dimensions LED-Display: 1084 x 464 mm

### FRAME

- Outer dimensions TACTIC: 1300 x 628 x 551 mm
- Aluminium and RVS bodywork

### ELECTRICAL CONNECTION

- 12V connection with 13pins connector

### OPTIONS

- Direction Indicators (front, back and sides)
- Traffic Advisor (eight LED-modules)
- Blue optical signalling
- Alley lights (left and right)
- Integrated GPRS/GPS router for real-time view at emergency room
- Static instead of rotatable display (lower price)
- Extra control panel (tablet)
- Emergency stop button

THE TACTIC DYNAMIC MEETS THE FOLLOWING STANDARDS  
NEN EN 12966 – NVN-ENV 12694 – NEN-EN-ISO 12100 – ECE 65

TACTIC DYNAMIC – A PRODUCT OF TTI PARTNERS BV

# TACTIC DYNAMIC

PRODUCT DETAILS



“ ADVANCED TECHNOLOGY PROCESSED TO THE LAST DETAIL. TOGETHER ON THE WAY TOWARDS A SAFER WORK ENVIRONMENT. ”

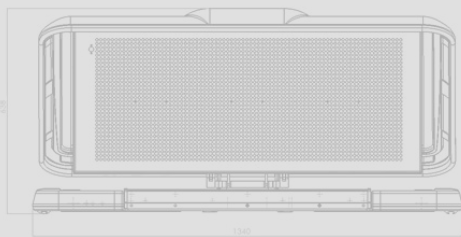

FRONTVIEW TACTIC DYNAMIC



SIDEVIEW TACTIC DYNAMIC

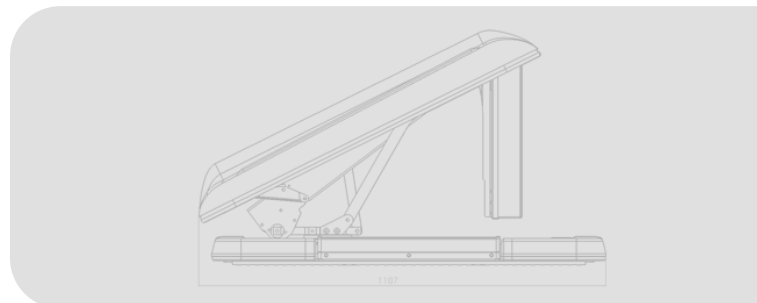

TOPVIEW TACTIC DYNAMIC FEND OFF

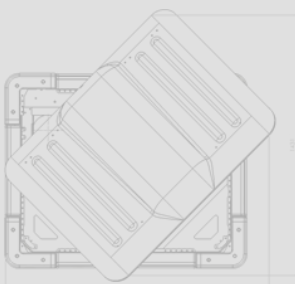

ROTATABLE UP TO 45° LEFT OR RIGHT  
MADE OF HIGH QUALITY RVS AND ALUMINIUM

# TACTIC DYNAMIC

## IN APP CONTROL



“ EVERY CONFLICT SITUATION NEEDS TIME AND ATTENTION. THANKS TO OUR EASY CONTROL PANEL FAST RESPONDING ON LOCATION IS POSSIBLE. ”

### TOUCHSCREEN

- Optical signalling and Dynamic Route Information Panel usable in one app
- Advanced Led-Display for optimal visibility
- Fast, safe and aimed action on location
- Divided in easy accesible tabs
- User friendly control panel

### SIGNALLING

- Optical signalling other than the TACTIC-system integrated in app
- Yellow button for active functions, grey button for inactive functions
- All signalling in one app

### SCENARIOS

- One-click-action to activate multiple symbols/signals
- Activating without danger while driving
- Combination of text with images possible

### IMAGES

- Preinstalled images on the TACTIC
- Unlimited possibilities for creating images

### APP FEATURES

- Operating: opening, closing and turning through one app
- Operating: more TACTICS in one app possible

CONNECTION BY Wi-Fi

USABLE TILL AROUND 100 METERS DISTANCE OF THE CAR

TACTIC DYNAMIC - A PRODUCT OF TTI PARTNERS BV

**TACTIC DYNAMIC**  
*DISPLAY POSSIBILITIES*



“ CLEAR MESSAGES FOR ROAD USERS WILL INCREASE THE ROAD SAFETY. THE POSSIBILITIES ARE UNLIMITED. ”

IMAGES – various scenarios possible

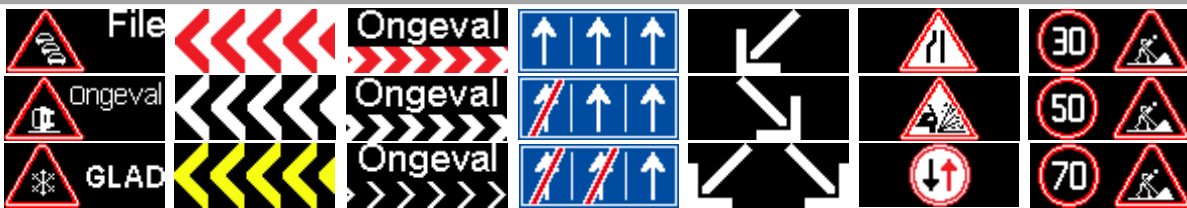

TEXTS – up to three lines possible



SLIDESHOW – chain of images are unlimited

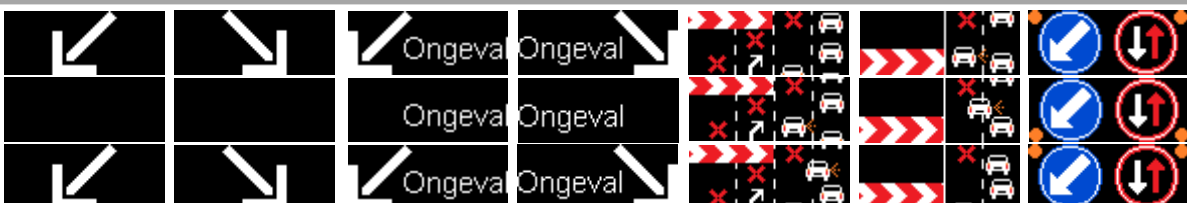

HIGHLY COMPLETE DELIVERED

UNLIMITED POSSIBILITIES TO PERSONALIZE

TACTIC DYNAMIC – A PRODUCT OF TTI PARTNERS BV

**TACTIC DYNAMIC**  
*TTI WORLDWIDE*



“ WORLDWIDE ROAD SAFETY. A SAFE WORK SITUATION IS POSSIBLE DUE TO OUR STRONG PARTNERSHIPS. ”



Rauwers – Belgium  
+32 (0)2 240 09 00



Rauwers – Germany  
+49 (0)2681 950 98 90



Sirac – France  
+33 (0)6 09 25 61 98



Rennicks – England  
+01928 579966



Tatweer – Abu Dhabi  
+971 2 441 55 51



Viateco Spółka – Poland  
+48 324 11 58 40



911Services – Austria  
+43 (0)623 290 303 911



Silca – the Netherlands  
+31 (0)344 722 944



Tamlans – Finland  
+385 10 682 1200

TOGETHER TOWARDS SAFER ROADS

TACTIC DYNAMIC

TACTIC DYNAMIC – A PRODUCT OF TTI PARTNERS BV



TACTIC